

FM Stereo FM/AM Receiver

Operating Instructions

STR-DA1500ES

WARNING

To reduce the risk of fire or electric shock, do not expose this apparatus to rain or moisture.

To reduce the risk of fire, do not cover the ventilation opening of the apparatus with newspapers, tablecloths, curtains, etc. Do not place the naked flame sources such as lighted candles on the apparatus.

Do not install the appliance in a confined space, such as a bookcase or built-in cabinet.

To reduce the risk of fire or electric shock, do not expose this apparatus to dripping or splashing, and do not place objects filled with liquids, such as vases, on the apparatus.

As the main plug is used to disconnect the unit from the mains, connect the unit to an easily accessible AC outlet. Should you notice an abnormality in the unit, disconnect the main plug from the AC outlet immediately.

Do not expose batteries or apparatus with battery-installed to excessive heat such as sunshine, fire or the like.

The unit is not disconnected from the mains as long as it is connected to the AC outlet, even if the unit itself has been turned off.

Excessive sound pressure from earphones and headphones can cause hearing loss.

For customers in the United States and Canada



This symbol is intended to alert the user to the presence of the Hot Surface that may be hot if it is touched during the normal operation.



ENERGY STAR[®] is a U.S. registered mark. As an ENERGY STAR[®] partner, Sony Corporation has determined that this product meets the ENERGY STAR[®] guidelines for energy efficiency.

For customers in the United States

Owner's Record

The model and serial numbers are located on the rear of the unit. Record these numbers in the space provided below. Refer to them whenever you call upon your Sony dealer regarding this product.

Model No. _____ Serial No. _____



This symbol is intended to alert the user to the presence of uninsulated "dangerous voltage" within the product's enclosure that may be of sufficient magnitude to constitute a risk of electric shock to persons.



This symbol is intended to alert the user to the presence of important operating and maintenance (servicing) instructions in the literature accompanying the appliance.

Important Safety Instructions

- 1) Read these instructions.
- 2) Keep these instructions.
- 3) Heed all warnings.
- 4) Follow all instructions.
- 5) Do not use this apparatus near water.
- 6) Clean only with dry cloth.
- 7) Do not block any ventilation openings. Install in accordance with the manufacturer's instructions.
- 8) Do not install near any heat sources such as radiators, heat registers, stoves, or other apparatus (including amplifiers) that produce heat.
- 9) Do not defeat the safety purpose of the polarized or grounding-type plug. A polarized plug has two blades with one wider than the other. A grounding type plug has two blades and a third grounding prong. The wide blade or the third prong are provided for your safety. If the provided plug does not fit into your outlet, consult an electrician for replacement of the obsolete outlet.
- 10) Protect the power cord from being walked on or pinched particularly at plugs, convenience receptacles, and the point where they exit from the apparatus.
- 11) Only use attachments/accessories specified by the manufacturer.

- 12) Use only with the cart, stand, tripod, bracket, or table specified by the manufacturer, or sold with the apparatus. When a cart is used, use caution when moving the cart/apparatus combination to avoid injury from tip-over.



- 13) Unplug this apparatus during lightning storms or when unused for long periods of time.
- 14) Refer all servicing to qualified service personnel. Servicing is required when the apparatus has been damaged in any way, such as power-supply cord or plug is damaged, liquid has been spilled or objects have fallen into the apparatus, the apparatus has been exposed to rain or moisture, does not operate normally, or has been dropped.

The following FCC statement applies only to the version of this model manufactured for sale in the U.S.A. Other versions may not comply with FCC technical regulations.

NOTE:

This equipment has been tested and found to comply with the limits for a Class B digital device, pursuant to Part 15 of the FCC Rules. These limits are designed to provide reasonable protection against harmful interference in a residential installation.

This equipment generates, uses and can radiate radio frequency energy and, if not installed and used in accordance with the instructions, may cause harmful interference to radio communications. However, there is no guarantee that interference will not occur in a particular installation. If this equipment does cause harmful interference to radio or television reception, which can be determined by turning the equipment off and on, the user is encouraged to try to correct the interference by one or more of the following measures:

- Reorient or relocate the receiving antenna.
- Increase the separation between the equipment and receiver.
- Connect the equipment into an outlet on a circuit different from that to which the receiver is connected.
- Consult the dealer or an experienced radio/TV technician for help.

CAUTION

You are cautioned that any changes or modifications not expressly approved in this manual could void your authority to operate this equipment.

To reduce the risk of electric shock, the speaker cord should be connected to the apparatus and the speakers in accordance with the following instructions.

- 1) Disconnect the AC power cord from the MAINS.
- 2) Strip 10 to 15 mm of the wire insulation of the speaker cord.
- 3) Connect the speaker cord to the apparatus and the speakers carefully so as not to touch the core of speaker cord by hand. Also disconnect the AC power cord from the MAINS before disconnecting the speaker cord from the apparatus and the speakers.

About This Manual

- The instructions in this manual are for model STR-DA1500ES. Check your model number by looking at the lower right corner of the front panel. In this manual, models of area code UC is used for illustration purposes unless stated otherwise. Any difference in operation is clearly indicated in the text, for example, “Models of area code UC only”.
- The instructions in this manual describe the controls on the supplied remote. You can also use the controls on the receiver if they have the same or similar names as those on the remote.

About area codes

The area code of the receiver you purchased is shown on the lower right portion of the rear panel (see the illustration below).

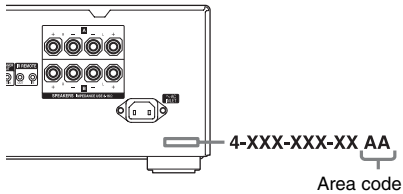

Any differences in operation, according to the area code, are clearly indicated in the text, for example, “Models of area code AA only”.

On Copyrights

SIRIUS, XM and all related marks and logos are trademarks of Sirius XM Radio Inc. and its subsidiaries. All rights reserved.

Table of Contents

Description and location of parts 6

Getting Started

1: Installing the speakers.....	13
2: Connecting the speakers	13
3a: Connecting the audio components	14
3b: Connecting the video components	15
4: Connecting the antennas (aerials)	19
5: Preparing the receiver and the remote.....	19
6: Selecting the speaker system	21

Playback

Enjoying sound/images from the component connected to the receiver.....	22
--	----

Amplifier Operations

Navigating through menus	24
Adjusting the level (LEVEL menu)	26
Adjusting the equalizer (EQ menu)	26
Settings for the tuner (TUNER menu)	27
Settings for the system (SYSTEM menu)...	28

Tuner Operations

Listening to FM/AM radio	29
Presetting radio stations	31
Listening to Satellite Radio.....	33
Connecting a satellite radio tuner.....	34
Preparing to listen to a satellite radio.....	34
Selecting a channel of the satellite radio.....	37
Presetting satellite radio channels	38
Restricting access to specific channels (Parental Lock) (SIRIUS only)	40

Other Operations

Enjoying the DIGITAL MEDIA PORT (DMPORT)	44
Changing the display.....	46
Using the Sleep Timer.....	47
Recording using the receiver.....	47
Using multi-zone features	48

Using the Remote

Changing button assignments.....	51
----------------------------------	----

Additional Information

Precautions	52
Troubleshooting.....	53
Specifications	56
Index.....	58

Description and location of parts

Front panel

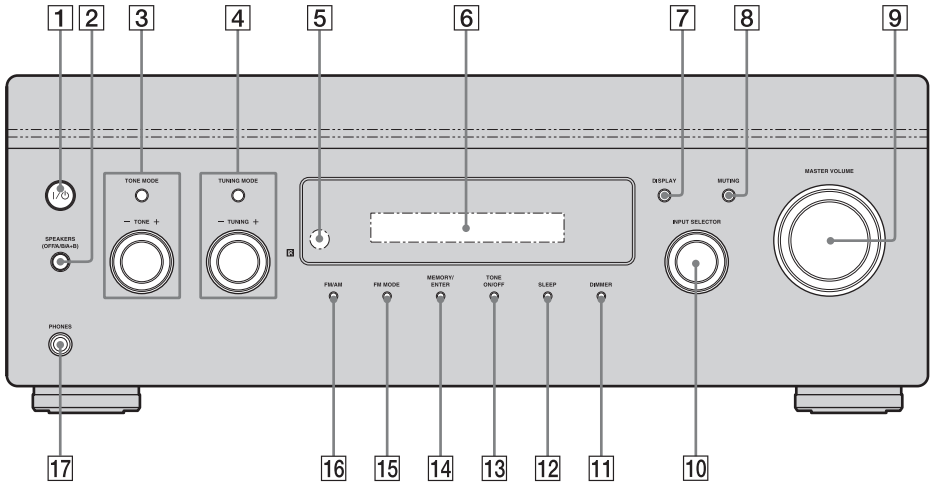

About the indicators on the display

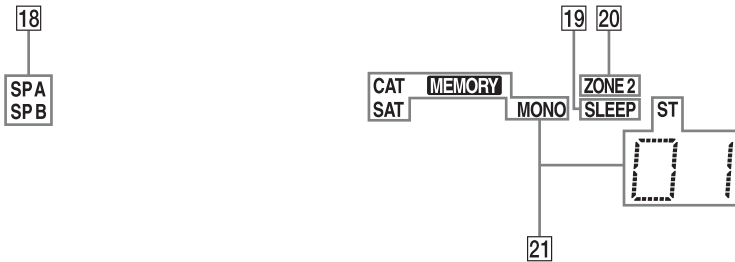

Name	Function
1 I/⏻ (on/standby)	Press to turn the receiver on or off (page 20, 30).
2 SPEAKERS (OFF/A/B/A+B)	Switch to OFF, A, B, A+B of the front speakers (page 21).
3 STONE MODE TONE +/-	Adjust the bass and treble level of the speakers. Press TONE MODE repeatedly to select bass or treble, then turn TONE +/- to adjust the level (page 25).
4 TUNING MODE TUNING +/-	Press to operate a tuner (FM/AM) and satellite radio (XM/SIRIUS) (page 29, 36, 37).
5 Remote sensor	Receives signals from remote commander.
6 Display window	The current status of the selected component or a list of selectable items appears here (page 6).
7 DISPLAY	Press repeatedly to select information displayed on the display (page 46).
8 MUTING	Press to turn off the sound temporarily. Press MUTING again to restore the sound (page 23).
9 MASTER VOLUME	Turn to adjust the volume level of all speakers at the same time (page 22).
10 INPUT SELECTOR	Turn to select the input source to play back (page 22, 23, 46, 47, 48).
11 DIMMER	Press repeatedly to adjust the brightness of the display.
12 SLEEP	Press to activate the sleep timer function and the duration which the receiver turns off automatically (page 47).
13 TONE ON/OFF	Press to turn the bass and treble on or off.
14 MEMORY/ ENTER	Press to store a station or enter the selection when selecting the settings (page 20, 31, 39).

Name	Function
15 FM MODE	Press to select the FM monaural or stereo reception (page 29).
16 FM/AM	Press to select FM or AM station.
17 PHONES jack	Connects to headphones (page 53).
18 SP A/SP B	Lights up according to the speaker system used (page 21). However, these indicators do not light up if the speaker output is turned off or if headphones are connected.
19 SLEEP	Lights up when the sleep timer is activated.
20 ZONE 2	Lights up when operation in zone 2 is being enabled.
21 Tuning indicators	Lights up when the receiver tunes in radio stations, or satellite radio stations.
CAT	Lights up when the category mode is set to "ONE CAT" during the satellite radio operation.
SAT	Lights up when the satellite radio is connected and "XM RADIO" or "SIRIUS" is selected.
MEMORY	Lights up when a memory function, such as Preset Memory (page 31), etc., is activated.
MONO	Monaural broadcast
ST	Stereo broadcast
	A preset station number appears when the preset radio station is selected.
Note	The preset station number will change accordingly to the preset station you select. For details on presetting radio station, see page 31.

Rear panel

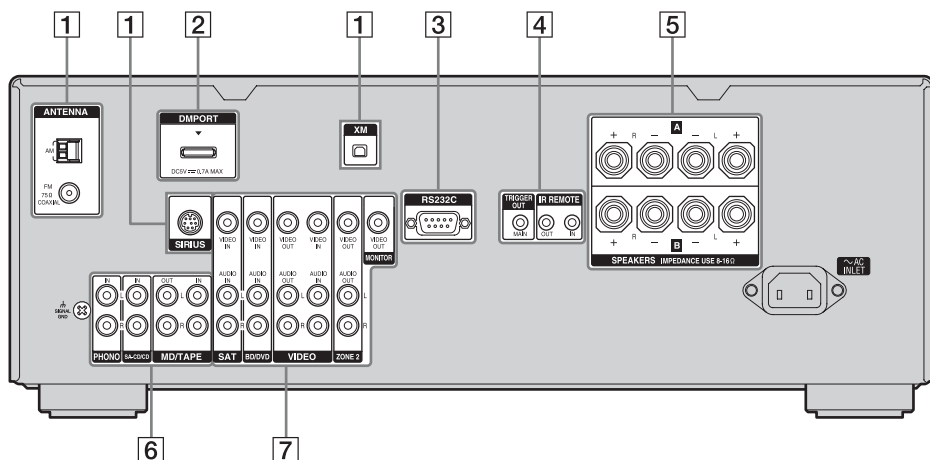

1 ANTENNA section



FM ANTENNA jack Connects to the supplied FM wire antenna (aerial) (page 19).



AM ANTENNA jack Connects to the supplied AM loop antenna (aerial) (page 19).



XM jack Connects to the XM Mini-Tuner and Home Dock (not supplied) (page 34).



SIRIUS jack Connects to a SiriusConnect Home tuner (not supplied) (page 34).

2 DMPORT



DMPORT jack Connects to a DIGITAL MEDIA PORT adapter (page 45).

3 RS232C port

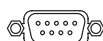

Used for maintenance and service.

4 Control jacks for Sony equipment and other external components



IR REMOTE IN/OUT jacks Connect an IR repeater (page 48).



TRIGGER OUT jack Connects to an interlock on/off of the power supply of other 12V TRIGGER compliant components, or the amplifier/receiver of zone 2 (page 28).

5 SPEAKERS section

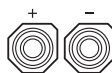

Connects to the speakers (page 13).

6 AUDIO INPUT/OUTPUT section



White (L) AUDIO IN/OUT jacks Connects to a tape deck or MD deck, etc. (page 14).



Red (R)

7 VIDEO/AUDIO INPUT/OUTPUT section

 White (L) AUDIO IN/ OUT jacks Connects to a VCR, DVD player, etc. (page 16–18).

 Red (R)

 Yellow VIDEO IN/ OUT* jacks



AUDIO OUT jacks Connects to the component in zone 2 (page 49).
 VIDEO OUT jack

* You can watch the selected input image when you connect the MONITOR OUT jack to a TV (page 16–18).

Remote commander

You can use the supplied RM-AAU056 Remote Commander to operate the receiver and to control the Sony audio/video components that the remote is assigned to operate (page 51).



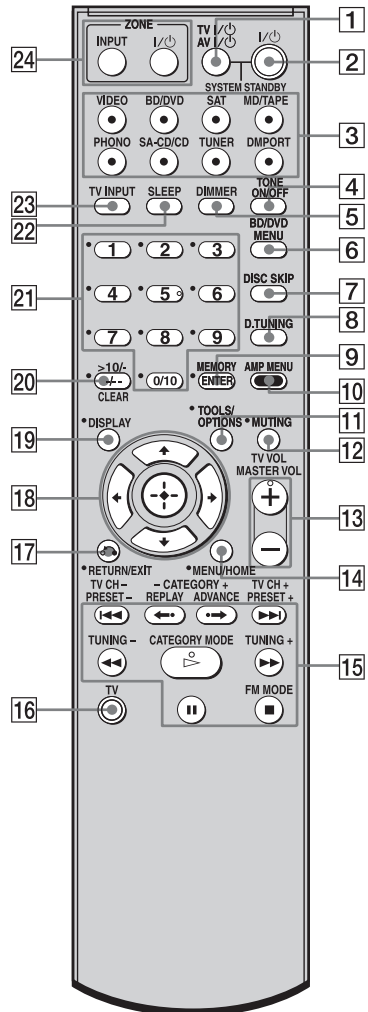



RM-AAU056





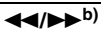













continued

Name	Function
1 TV I/⏻ (on/standby)	Press TV I/⏻ and TV (16) at the same time to turn the TV on or off.
AV I/⏻ (on/standby)	Press to turn on or off the Sony audio/video components that the remote is assigned to operate (page 51). If you press I/⏻ (2) at the same time, it will turn off the receiver and other Sony components (SYSTEM STANDBY). Note The function of the AV I/⏻ switch changes automatically each time you press the input buttons (3).
2 I/⏻ (on/standby)	Press to turn the receiver on or off. If zone 2 is selected, only the main receiver is turned on or off with this button. To turn off all components including an amplifier in zone 2, press I/⏻ and AV I/⏻ (1) at the same time (SYSTEM STANDBY). Saving the power in standby mode. When “RS232C” (page 28) is set to “OFF”.
3 Input buttons	Press one of the buttons to select the component you want to use. When you press any of the input buttons, the receiver turns on. The buttons are factory assigned to control Sony components. You can change the button assignments following the steps in “Changing button assignments” on page 51.
4 TONE ON/OFF	Press to turn the bass and treble on or off.
5 DIMMER	Press repeatedly to adjust the brightness of the display.

Name	Function
6 BD/DVD MENU	Press to display the menu of the DVD or Blu-ray disc on the TV screen. Then, use ⬆, ⬇, ⬅, ➡ and ⊕ (18) to perform menu operations.
7 DISC SKIP	Press to skip a disc when using a multi-disc changer.
8 D.TUNING	Press to enter direct tuning mode.
9 ENTER	Press to enter the value after selecting a channel, disc or track using the numeric buttons of the TV, VCR, CD player, DVD player, DVD recorder or satellite tuner.
MEMORY	Press to store a station during tuner operation.
10 AMP MENU	Press to display the menu of the receiver. Then, use ⬆, ⬇, ⬅, ➡ and ⊕ (18) to perform menu operations.
11 TOOLS/OPTIONS	Press to display and select the options of the DVD player or Blu-ray disc player. Press TOOLS/OPTIONS and TV (16) at the same time to display the options applicable to the Sony TV.
12 MUTING	Press to turn off the sound temporarily. Press MUTING again to restore the sound. Press MUTING and TV (16) at the same time to activate the TV’s muting function.
13 TV VOL +^a/–	Press TV VOL +/– and TV (16) at the same time to adjust the volume level of the TV.
MASTER VOL +^a/–	Press to adjust the volume level of all speakers at the same time.
14 MENU/HOME	Press to display the menu of the VCR, DVD player, satellite tuner or Blu-ray disc player on the TV screen. Press MENU/HOME and TV (16) at the same time to display the TV’s menu. Then, use ⬆, ⬇, ⬅, ➡ and ⊕ (18) to perform menu operations.

Name	Function
15  ^{b)}	Press to skip a track of the CD player, DVD player, DVD recorder, MD deck, tape deck or Blu-ray disc player.
REPLAY  / ADVANCE 	Press to replay the previous scene or fast forward the current scene of the VCR, DVD player or Blu-ray disc player.
 ^{b)}	Press to – search tracks in the forward/reverse direction of the DVD player. – start fast forward/rewind of the VCR, CD player, DVD recorder, MD deck, tape deck or Blu-ray disc player.
 ^{a)b)}	Press to start playback of the VCR, CD player, DVD player, DVD recorder, MD deck or Blu-ray disc player.
 ^{b)}	Press to pause playback or recording of the VCR, CD player, DVD player, DVD recorder, MD deck, tape deck or Blu-ray disc player. (Also starts recording with components in recording standby.)
 ^{b)}	Press to stop playback of the VCR, CD player, DVD player, DVD recorder, MD deck, tape deck or Blu-ray disc player.
TV CH +/-	Press TV CH +/- and TV  at the same time to select preset TV channels.
CATEGORY +/-	Press to select a category for satellite tuner (page 37).
PRESET +/-	Press to select – preset stations. – preset channels of the VCR or satellite tuner.
TUNING +/-	Press to scan a station.
CATEGORY MODE	Press to select the category mode for satellite tuner (page 37).
FM MODE	Press to select the FM monaural or stereo reception.

Name	Function
16 TV	Press TV and the button with orange printing at the same time to enable TV operation.
17 RETURN/EXIT 	Press to – return to the previous menu. – exit the menu while the menu or on-screen guide of the DVD recorder, DVD player, satellite tuner or Blu-ray disc player is displayed on the TV screen. Press RETURN/EXIT  and TV  at the same time to return to the previous menu or exit the TV's menu while the menu is displayed on the TV screen.
18  	After pressing BD/DVD MENU  , AMP MENU  () or MENU/HOME  () , press  ,  ,  or  to select the settings. Then, press  to enter the selection if you have pressed BD/DVD MENU or MENU/HOME previously. Press  also to enter the selection of the receiver, VCR, satellite tuner, CD player, DVD player, DVD recorder or Blu-ray disc player.
19 DISPLAY	Press to select information displayed on the TV screen of the VCR, satellite tuner, CD player, DVD player, DVD recorder, MD deck or Blu-ray disc player. Press DISPLAY and TV  at the same time to display TV's information on the TV screen.

continued

Name	Function
20 -/--	Press to select the channel entry mode, either one or two digit of the VCR, satellite tuner, etc. Press -/-- and TV (16) at the same time to select the channel entry mode, either one or two digits of the TV.
>10/-	Press to select – track numbers over 10 of the VCR, satellite tuner, MD deck or CD player. – channel numbers of the Digital CATV terminal.
CLEAR	Press to clear a mistake when you press the incorrect numeric button.
21 Numeric buttons (number 5^a)	Press to – preset/tune to preset stations. – select track numbers of the CD player, DVD player, DVD recorder, MD deck or Blu-ray disc player. Press 0/10 to select track number 10. – select channel numbers of the VCR or satellite tuner. Press the numeric buttons and TV (16) at the same time to select the TV channels.
22 SLEEP	Press to activate the Sleep Timer function and the duration which the receiver turns off automatically.
23 TV INPUT	Press TV INPUT and TV (16) at the same time to select the input signal (TV input or video input).
24 ZONE I/⏻	Press ZONE I/⏻ to turn the zone 2 on or off.
ZONE INPUT	Press ZONE INPUT repeatedly to select the input source for zone 2.

- a) The number 5, MASTER VOL +, TV VOL +, and  buttons have tactile dots. Use the tactile dots as references when operating the receiver.
- b) This button is also available for DIGITAL MEDIA PORT adapter operation. For details on the function of the button, refer to the operating instructions supplied with the DIGITAL MEDIA PORT adapter.

Notes

- Some functions explained in this section may not work depending on the model.
- The above explanation is intended to serve as an example only. Therefore, depending on the component, the above operation may not be possible or may operate differently than described.

1: Installing the speakers

This receiver allows you to use a 2.0 channel system.

Example of the speaker system configuration

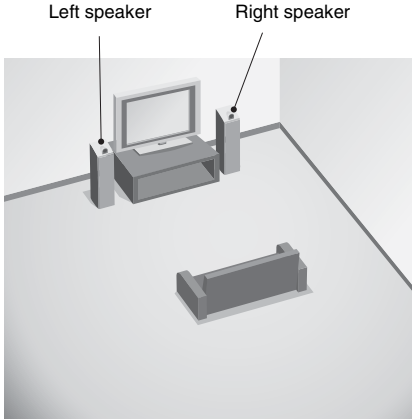

2: Connecting the speakers

Before connecting the cords, be sure to disconnect the AC power cord (mains lead).

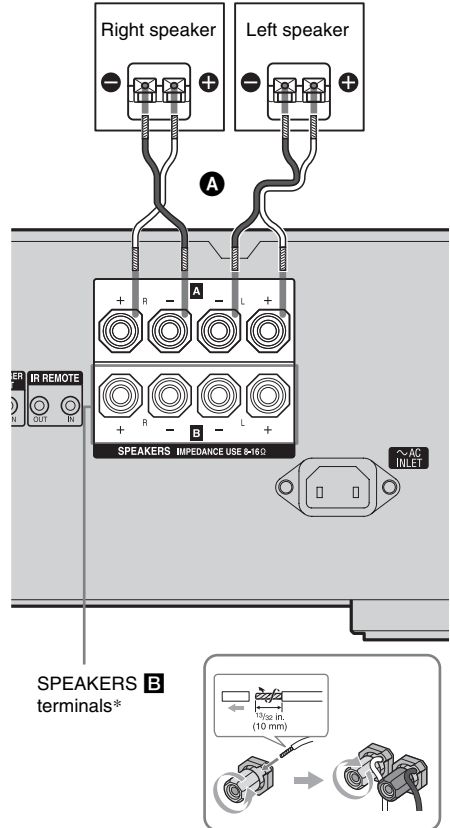

A Speaker cords (not supplied)

* If you have an additional front speaker system, connect them to the SPEAKERS **B** terminals. You can select the front speakers you want to use with SPEAKERS (OFF/A/B/A+B) on the front panel (page 21).

3a: Connecting the audio components

Connecting a Super Audio CD player, CD player, MD deck, Tape deck or Turntable

The following illustration shows how to connect a Super Audio CD player, CD player, MD deck, tape deck or turntable. Before connecting the cords, be sure to disconnect the AC power cord (mains lead). After connecting your audio component, proceed to “3b: Connecting the video components”(page 15).

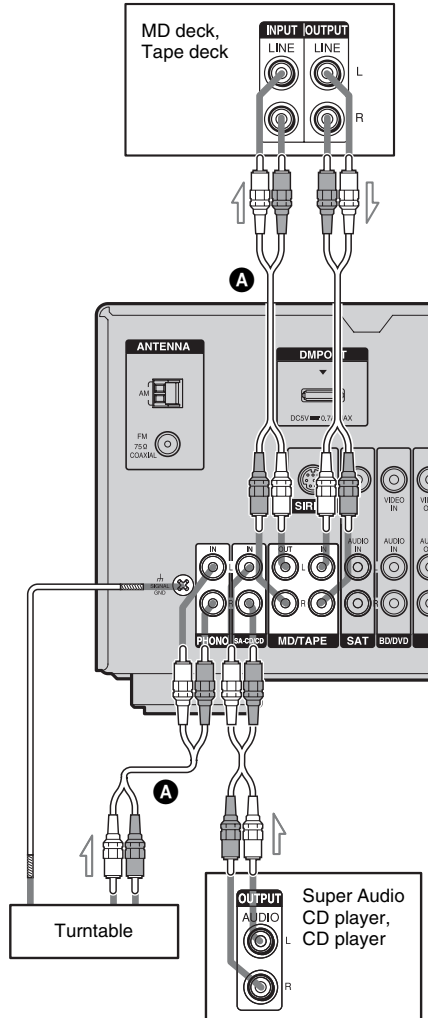

A Audio cord (not supplied)

Note

If your turntable has a ground (earth) wire, connect it to the (♁) SIGNAL GND terminal.

3b: Connecting the video components

How to connect your components

This section describes how to connect your video components to this receiver. Before you begin, refer to “Component to be connected” below for the pages which describe how to connect each component.

Before connecting the cords, be sure to disconnect the AC power cord (mains lead). After connecting all your components, proceed to “4: Connecting the antennas (aerials)” (page 19).

Component to be connected	Page
Blu-ray disc player, DVD player	16
Satellite tuner, Set-top box	17
DVD recorder, VCR	18

Connecting a Blu-ray disc player, DVD player

The following illustration shows how to connect a Blu-ray disc player or a DVD player. Connect audio and video cords according to the jacks of your components.

If you connect a DVD player

- Be sure to change the factory setting of the BD/DVD input button on the remote so that you can use the button to control your DVD player. For details, see “Changing button assignments” (page 51).
- You can also rename the BD/DVD input so that it can be displayed on the receiver’s display. For details, see “Naming inputs” (page 23).

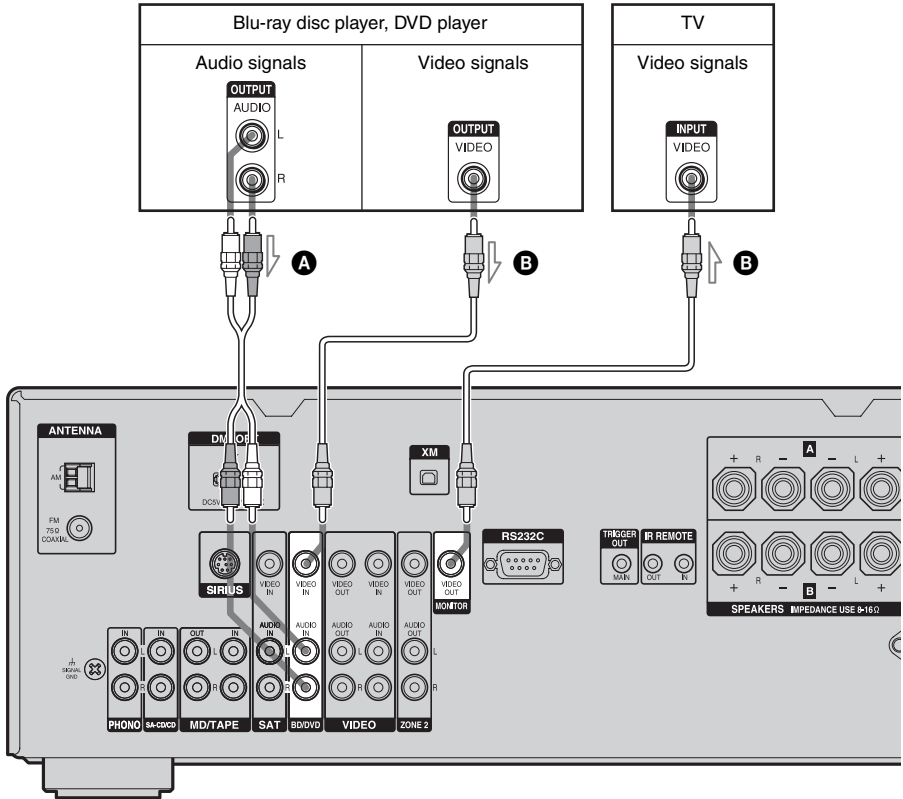

- A** Audio cord (not supplied)
- B** Video cord (not supplied)

Connecting a satellite tuner, Set-top box

The following illustration shows how to connect a satellite tuner or a Set-top box. Connect audio and video cords according to the jacks of your components.

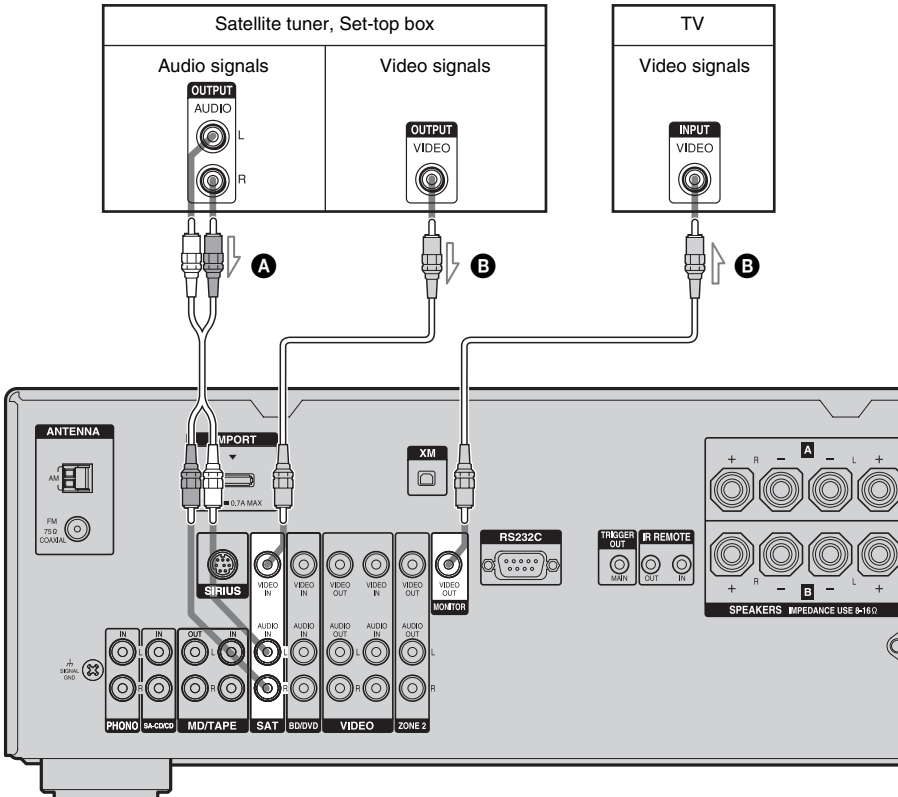

- A** Audio cord (not supplied)
- B** Video cord (not supplied)

Connecting components with analog video and audio jack

The following illustration shows how to connect a component which has analog jacks such as a DVD recorder, VCR, etc.

Connect audio and video cords according to the jacks of your components.

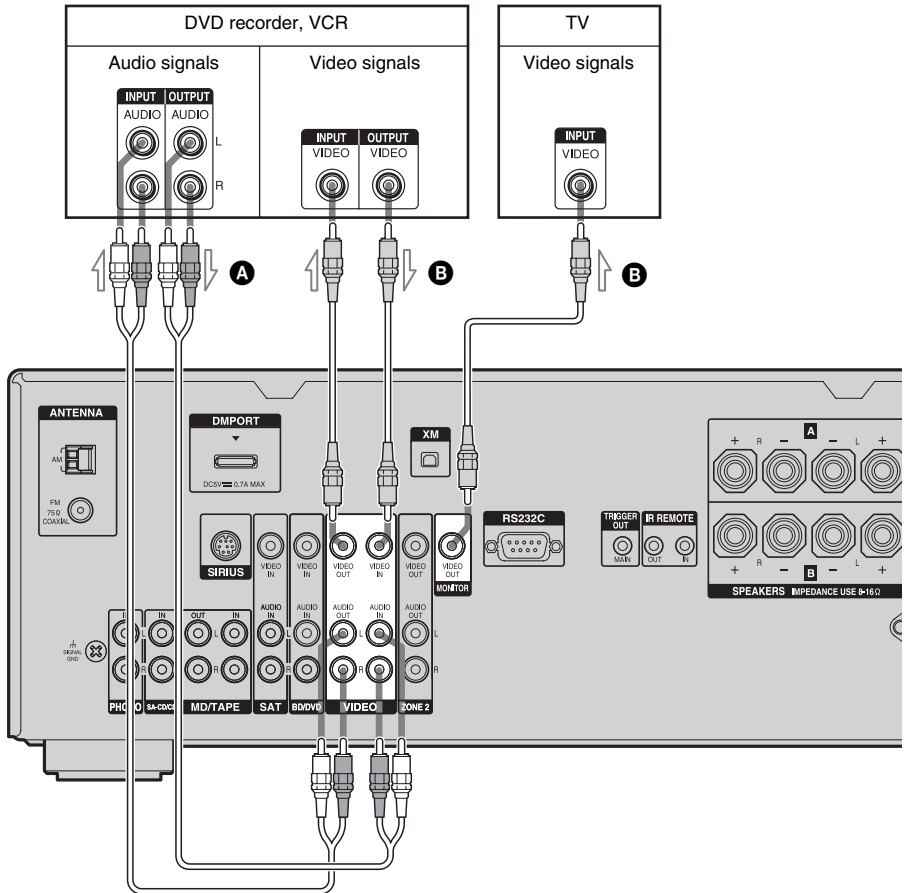

- A** Audio cord (not supplied)
- B** Video cord (not supplied)

Notes

- Be sure to change the factory setting of the VIDEO input button on the remote so that you can use the button to control your DVD recorder. For details, see “Changing button assignments” (page 51).

- You can also rename the VIDEO input so that it can be displayed on the receiver’s display. For details, see “Naming inputs” (page 23).

4: Connecting the antennas (aerials)

Connect the supplied AM loop antenna (aerial) and FM wire antenna (aerial). Before connecting the antennas (aerials), be sure to disconnect the AC power cord (mains lead).

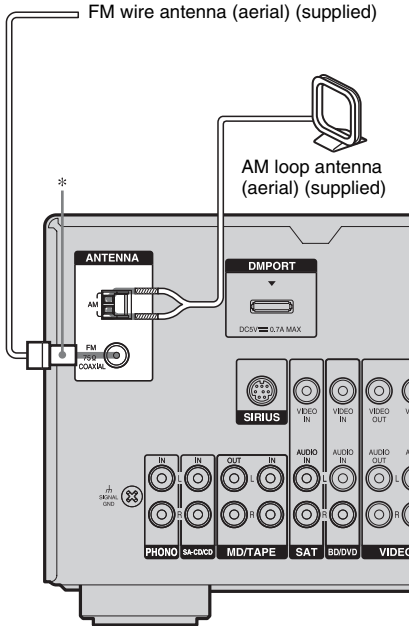

* The shape of the connector varies depending on the area code of this receiver.

Notes

- To prevent noise pickup, keep the AM loop antenna (aerial) away from the receiver and other components.
- Be sure to fully extend the FM wire antenna (aerial).
- After connecting the FM wire antenna (aerial), keep it as horizontal as possible.

5: Preparing the receiver and the remote

Connecting the AC power cord (mains lead)

Connect the supplied AC power cord (mains lead) to the AC INLET terminal on the receiver, then connect the AC power cord (mains lead) to a wall outlet.

Notes

- Before connecting the AC power cord (mains lead), make sure that metallic wires of the speaker cords are not touching each other between the SPEAKERS terminals.
- Connect the AC power cord (mains lead) firmly.

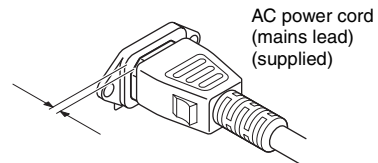
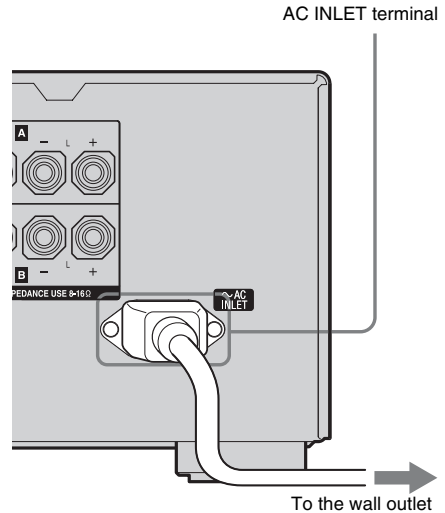

A several space is left between the plug and the rear panel even when the power cord (mains lead) is inserted firmly. The cord is supposed to be connected this way. This is not malfunction.

6: Selecting the speaker system

You can select the front speakers you want to drive.

Be sure to use the buttons on the receiver for this operation.

SPEAKERS (OFF/A/B/A+B)

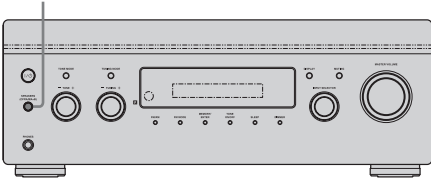

Press SPEAKERS (OFF/A/B/A+B) repeatedly to select the speaker system you want to drive.

To select	Light up
The speakers connected to the SPEAKERS A terminals	SP A
The speakers connected to the SPEAKERS B terminals	SP B
The speakers connected to the SPEAKERS A and B terminals (parallel connection)	SP A SP B

To turn off the speaker output

Press SPEAKERS (OFF/A/B/A+B) repeatedly until the “SP A” and “SP B” indicators on the display light off. “ALL OFF” appears on the display for a while.

Note

You cannot switch the speaker system by pressing SPEAKERS (OFF/A/B/A+B) when the headphones are connected to the receiver.

Playback

Enjoying sound/images from the component connected to the receiver

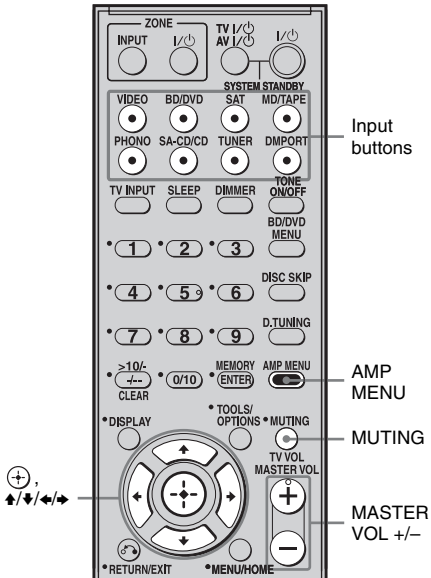

1 Press the input button to select a component.

You can also use INPUT SELECTOR on the receiver.

The selected input appears on the display.

Selected input [Display]	Components that can be played back
VIDEO [VIDEO]	DVD recorder, VCR, etc., connected to the VIDEO jack
BD/DVD [BD/DVD]	Blu-ray disc player, DVD player, etc., connected to the BD/DVD jack
SAT [SAT]	Satellite tuner, etc. connected to the SAT jack

Selected input [Display]	Components that can be played back
MD/TAPE [MD/TAPE]	MD deck, tape deck, etc., connected to MD/TAPE jack
PHONO [PHONO]	Turntable, etc., connected to the PHONO jack
SA-CD/CD [SA-CD/CD]	Super Audio CD, CD player, etc., connected to the SA-CD/CD jack
TUNER [FM TUNER or AM TUNER]	Built-in radio tuner
TUNER [XM RADIO or SIRIUS]	XM Mini-Tuner and Home Dock connected to the XM jack or SiriusConnect Home tuner connected to the SIRIUS jack
DMPORT [DMPORT]	DIGITAL MEDIA PORT adapter connected to the DMPORT jack

2 Turn on the component and start playback.

3 Press MASTER VOL +/- to adjust the volume.

You can also use MASTER VOLUME on the receiver.

Tips

- You can adjust the volume differently depending on the speed with which you turn the MASTER VOLUME on the receiver.
 - To turn the volume up or down quickly: turn the knob quickly.
 - To make fine adjustment: turn the knob slowly.
- You can adjust the volume differently depending on the length of time you press and hold the MASTER VOL +/- button on the remote.
 - To turn the volume up or down quickly: press and hold the button.
 - To make fine adjustment: press the button and release it immediately.

To activate the muting function

Press MUTING.

The muting function will be canceled when you do the following.

- Press MUTING again.
- Increase the volume.
- Turn off the receiver.

To avoid damaging your speakers

Before you turn off the receiver, be sure to turn down the volume level.

Naming inputs

You can enter a name of up to 8 characters for inputs and display it on the receiver's display. This is convenient for labeling the jacks with the names of the connected components.

1 Press the input button to select the input you want to create an index name for.

You can also use INPUT SELECTOR on the receiver.

2 Press AMP MENU.

"1-LEVEL" appears on the display.

3 Press \uparrow/\downarrow repeatedly to select "4-SYSTEM".

4 Press \oplus or \rightarrow to enter the menu.

5 Press \uparrow/\downarrow to select "NAME IN".

6 Press \oplus or \rightarrow to enter the parameter.

The cursor flashes and you can select a character.

7 Press \uparrow/\downarrow to select a character, then press \leftarrow/\rightarrow to move the cursor to the next position.

If you made a mistake

Press \leftarrow/\rightarrow until the character you want to change flashes, then press \uparrow/\downarrow to select the correct character.

Tips

- You can select the character type as follows by pressing \uparrow/\downarrow .
Alphabet (upper case) \rightarrow Numbers \rightarrow Symbols
- To enter a blank space, press \rightarrow without selecting a character.

8 Press \oplus .

The name you entered is registered.

Amplifier Operations

Navigating through menus

By using the amplifier menus, you can make various adjustments to customize the receiver.

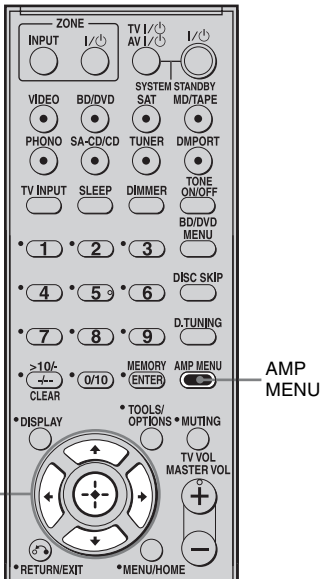

- 1 Press AMP MENU.**
“1-LEVEL” appears on the display.
- 2 Press \uparrow/\downarrow repeatedly to select the menu you want.**
- 3 Press \oplus or \rightarrow to enter the menu.**
- 4 Press \uparrow/\downarrow repeatedly to select the parameter you want to adjust.**
- 5 Press \oplus or \rightarrow to enter the parameter.**

- 6 Press \uparrow/\downarrow repeatedly to select the setting you want.**

The setting is entered automatically.

To return to the previous display

Press \leftarrow .

To exit the menu

Press AMP MENU.

Note

Some parameters and settings may appear dimmed on the display. This means that they are either unavailable or fixed and unchangeable.

Overview of the menus

The following options are available in each menu. For details on navigating through menus, see page 24.

Menu [Display]	Parameters [Display]	Settings	Initial setting
LEVEL [1-LEVEL] (page 26)	Front speaker balance ^{a)} [FRT BAL]	BAL. L +1 to BAL. L +10, BALANCE, BAL. R +1 to BAL. R +10	BALANCE
EQ [2-EQ] (page 26)	Front speaker bass level ^{a)} [BASS LVL]	BASS -10 dB to BASS +10 dB (1 dB step)	BASS 0 dB
	Front speaker treble level ^{a)} [TRE LVL]	TRE -10 dB to TRE +10 dB (1 dB step)	TRE 0 dB
TUNER [3-TUNER] (page 27)	FM station receiving mode ^{a)} [FM MODE]	STEREO, MONO	STEREO
	Naming preset stations ^{a)} [NAME IN]	For details, see “Naming preset stations” (page 32).	
	XM antenna aiming mode ^{a)b)} [XM ANT]	For details, see “Checking receiving conditions (Antenna Aiming)” (page 35).	
	XM radio ID ^{a)b)} [XM ID]	For details, see “Checking the ID number” (page 34).	
	Parental lock ^{a)c)} [PARENTAL]	OFF, ON	OFF
	Sirius lock code edit ^{a)c)} [CODE EDT.]	For details, see “To change the lock code” (page 40).	
	Sirius antenna aiming mode ^{a)c)} [SR ANT]	For details, see “Checking receiving conditions (Antenna Aiming)” (page 35).	
	Sirius radio ID ^{a)c)} [SR ID]	For details, see “Checking the ID number” (page 34).	
SYSTEM [4-SYSTEM] (page 28)	Naming inputs ^{a)} [NAME IN]	For details, see “Naming inputs” (page 23).	
	Brightness of the display ^{a)} [DIMMER]	0% dim, 40% dim, 70% dim	0% dim
	12V Trigger ^{a)} [12V TRIG.]	INPUT, ZONE, CTRL, OFF	OFF
	RS232C Control ^{a)} [RS232C]	ON, OFF	ON

^{a)}For details, refer to the page in the parentheses.

^{b)}This parameter is only available if the XM Mini-Tuner and Home Dock is connected to the XM jack on the receiver.

^{c)}This parameter is only available if the SiriusConnect Home tuner is connected to the SIRIUS jack on the receiver.

Adjusting the level (LEVEL menu)

You can use the LEVEL menu to adjust the balance of front speakers.

Select “1-LEVEL” in the amplifier menus. For details on adjusting the parameters, see “Navigating through menus” (page 24) and “Overview of the menus” (page 25).

LEVEL menu parameters

■ FRT BAL (Front speaker balance)

Lets you adjust the balance between front left and right speakers.

Adjusting the equalizer (EQ menu)

You can use the EQ menu to adjust the tonal quality (bass/treble level) of the front speakers.

Select “2-EQ” in the amplifier menus. For details on adjusting the parameters, see “Navigating through menus” (page 24) and “Overview of the menus” (page 25).

EQ menu parameters

■ BASS LVL (Front speaker bass level)

■ TRE LVL (Front speaker treble level)

Settings for the tuner

(TUNER menu)

You can use the TUNER menu to set the FM station receiving mode and to name preset stations.

Select “3-TUNER” in the amplifier menus. For details on adjusting the parameters, see “Navigating through menus” (page 24) and “Overview of the menus” (page 25).

TUNER menu parameters

■ FM MODE (FM station receiving mode)

- STEREO
This receiver will decode the signal as stereo signal when the radio station is broadcast in stereo.
- MONO
This receiver will decode the signal as mono signal regardless of the broadcast signal.

■ NAME IN (Naming preset stations)

Lets you set the name of preset stations. For details, see “Naming preset stations” (page 32).

■ XM ANT (XM antenna aiming mode)

This parameter helps you to aim the XM antenna for optimal signal reception. For details, see “Checking receiving conditions (Antenna Aiming)” (page 35).

■ XM ID (XM radio ID)

Lets you check the XM Radio ID. For details, see “Checking the ID number” (page 34).

■ PARENTAL (Parental lock)

Lets you restrict access to certain channels using your own lock code. For details, see “Restricting access to specific channels (Parental Lock) (SIRIUS only)” (page 40).

■ CODE EDT. (Sirius lock code edit)

Lets you change the lock code. For details, see “To change the lock code” (page 40).

■ SR ANT (Sirius antenna aiming mode)

This parameter helps you to aim the SIRIUS antenna for optimal signal reception. For details, see “Checking receiving conditions (Antenna Aiming)” (page 35).

■ SR ID (Sirius radio ID)

Lets you check the Sirius Radio ID. For details, see “Checking the ID number” (page 34).

Settings for the system

(SYSTEM menu)

You can use the SYSTEM menu to customize the settings of the receiver.

Select “4-SYSTEM” in the amplifier menus. For details on adjusting the parameters, see “Navigating through menus” (page 24) and “Overview of the menus” (page 25).

SYSTEM menu parameters

■ NAME IN (Naming inputs)

Lets you set the name of inputs. For details, see “Naming inputs” (page 23).

■ DIMMER (Brightness of the display)

Lets you adjust the brightness in 3 steps.

■ 12V TRIG. (12V Trigger)

Lets you turn the receiver on/off in another zone, or select various option for use of the 12V Trigger function.

- INPUT (for main zone only)
Lets you turn on the output of 12V triggers when the preset input is selected.
When you select “INPUT”, the setting display which sets each input trigger to on/off appears. Press $\blacktriangle/\blacktriangledown$ to select the input, then press \oplus . Press $\blacktriangle/\blacktriangledown$ again to select “ON” or “OFF”, then press \oplus .
- ZONE
Lets you turn the output of 12V triggers on or off based on whether the selected zone is turned on or off.
- CTRL
Lets you turn the output of 12V triggers on or off manually using the CIS command of the IR remote.
- OFF
Lets you turn off output of 12V triggers even when the main receiver is turned on.

Tips

- Even when this receiver is in standby mode (press $I/\text{⏻}$ on the remote to turned off this receiver), the receiver in zone 2 remains turned on. To turn off all receivers, press $I/\text{⏻}$ and AV $I/\text{⏻}$ on the RM-AAU056 remote at the same time (SYSTEM STANDBY).
- Only signals from components connected to the analog input jacks are output through the ZONE 2 OUT jacks.
- When tuner is selected; the same type of radio station (FM/AM) selected in the main zone is set in zone 2. However, you can select the input other than tuner in zone 2.
- When the receiver in the main zone is turned off, or an input source other than tuner is selected, you can select a radio station from AM or FM in zone 2. When the receiver in the main zone or zone 2 is turned off, you can select a broadcast from FM/AM/XM/SIRIUS in one zone in which the receiver is turned on.

■ RS232C (RS232C Control)

Lets you use this menu for the zone 2 operation.

- ON
The receiver can receive commands from the RS232C port.
- OFF
The receiver does not receive commands from the RS232C port.

Tuner Operations

Listening to FM/AM radio

You can listen to FM and AM broadcasts through the built-in tuner. Before operation, make sure you have connected the FM and AM antennas (aerials) to the receiver (page 19).

Tip

The tuning scale for direct tuning differs depending on the area code as shown in the following table. For details on area codes, see page 34.

Area code	FM	AM
UC	100 kHz	10 kHz*

* The AM tuning scale can be changed (page 30).

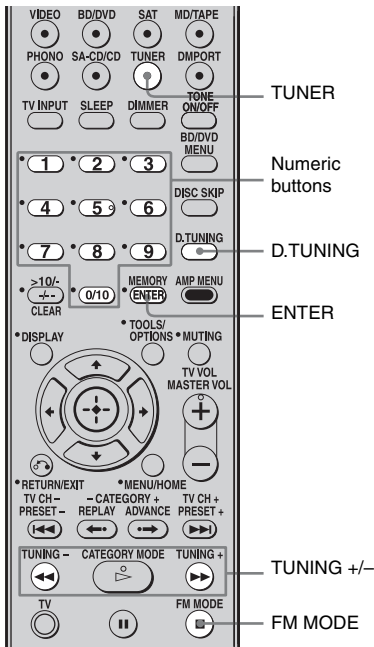

Tuning into a station automatically (Auto Tuning)

- 1 Press TUNER repeatedly to select the FM or AM band.
- 2 Press TUNING + or TUNING -. Press TUNING + to scan from low to high; press TUNING - to scan from high to low. The receiver stops scanning whenever a station is received.

Using the controls on the receiver

- 1 Press FM/AM repeatedly to select the FM or AM band.
- 2 Press TUNING MODE repeatedly to select "AUTO".
- 3 Turn TUNING + or TUNING -.

In case of poor FM stereo reception

If the FM stereo reception is poor and "ST" flashes on the display, select monaural audio so that the sound will be less distorted. Press FM MODE repeatedly until the "MONO" indicator lights up on the display. To return to stereo mode, press FM MODE repeatedly until the "MONO" indicator on the display does not light up.

Tuning into a station directly (Direct Tuning)

Enter the frequency of a station directly by using the numeric buttons.

- 1 Press TUNER repeatedly to select the FM or AM band.**
You can also use FM/AM on the receiver.
- 2 Press D.TUNING.**
- 3 Press the numeric buttons to enter the frequency.**

Example 1: FM 102.50 MHz

Select 1 → 0 → 2 → 5

Example 2: AM 1,350 kHz

Select 1 → 3 → 5 → 0

If you have tuned in an AM station, adjust the direction of the AM loop antenna (aerial) for optimum reception.

- 4 Press ENTER or .**

You can also use MEMORY/ENTER on the receiver.

If you cannot tune in a station

Make sure you have entered the right frequency. If not, repeat steps 2 to 4. If you still cannot tune in a station, the frequency is not used in your area.

Changing the AM tuning scale

(Model of area code UC only)

You can change the AM tuning scale to either 9 kHz or 10 kHz using the buttons on the receiver.

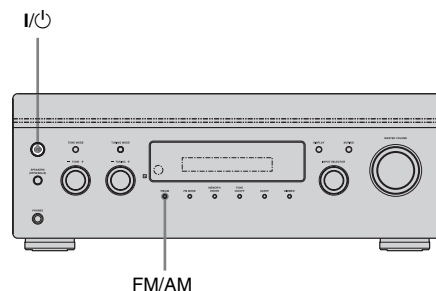

- 1 Press I/Power to turn off the receiver.**
- 2 While holding down FM/AM, press I/Power.**
- 3 Change the current AM tuning scale to 9 kHz (or 10 kHz).**

To reset the scale to 10 kHz (or 9 kHz), repeat the procedure above.

Note

All preset stations will be erased when you change the tuning scale.

Presetting radio stations

You can preset up to 30 FM stations and 30 AM stations. Then you can easily tune in the stations you often listen to.

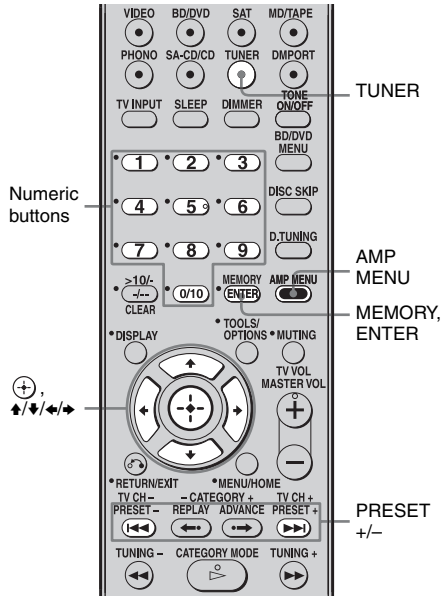

1 Press TUNER repeatedly to select the FM or AM band.

You can also use FM/AM on the receiver.

2 Tune in the station that you want to preset using Auto Tuning (page 29) or Direct Tuning (page 30).

In case of poor FM stereo reception, switch the FM reception mode (page 29).

3 Press MEMORY.

You can also use MEMORY/ENTER on the receiver.

“MEMORY” lights up for a few seconds. Perform steps 4 and 5 before “MEMORY” goes out.

4 Press the numeric buttons to select a preset number.

You can also press PRESET + or PRESET – to select a preset number.

If “MEMORY” goes out before you select the preset number, start again from step 3.

5 Press ENTER.

You can also use MEMORY/ENTER on the receiver.

The station is stored as the selected preset number.

If “MEMORY” goes out before you press ENTER, start again from step 3.

6 Repeat steps 1 to 5 to preset another station.

Tuning to preset stations

1 Press TUNER repeatedly to select the FM or AM band.

2 Press PRESET + or PRESET – repeatedly to select the preset station you want.

Each time you press the button, you can select a preset station as follows:

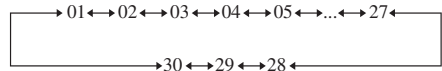

You can also press the numeric buttons to select the preset station you want. Then, press ENTER to enter the selection.

Using the controls on the receiver

1 Press FM/AM repeatedly to select the FM or AM band.

2 Press TUNING MODE repeatedly to select “PRESET”.

3 Turn TUNING + or TUNING – to select the preset station you want.

Naming preset stations

- 1 Press TUNER repeatedly to select the FM or AM band.**

You can also use FM/AM on the receiver.
- 2 Tune in the preset station you want to create an index name for (page 31).**
- 3 Press AMP MENU.**

“1-LEVEL” appears on the display.
- 4 Press \uparrow/\downarrow repeatedly to select “3-TUNER”.**
- 5 Press \oplus or \rightarrow to enter the menu.**
- 6 Press \uparrow/\downarrow repeatedly to select “NAME IN”.**
- 7 Press \oplus or \rightarrow to enter the parameter.**

The cursor flashes and you can select a character.
- 8 Press \uparrow/\downarrow to select a character, then press \leftarrow/\rightarrow to move the cursor to the next position.**

If you made a mistake

Press \leftarrow/\rightarrow until the character you want to change flashes, then press \uparrow/\downarrow to select the correct character.

Tips

 - You can select the character type as follows by pressing \uparrow/\downarrow .
Alphabet (upper case) \rightarrow Numbers \rightarrow
Symbols
 - To enter a blank space, press \rightarrow without selecting a character.
- 9 Press \oplus .**

The name you entered is registered.

Listening to Satellite Radio

To listen to Satellite Radio, you'll need to connect either a SIRIUS or XM Satellite Radio tuner (sold separately) to your satellite-ready receiver. Satellite Radio is available to residents of the US (except Alaska and Hawaii) and Canada.

Satellite Radio delivers a variety of commercial-free music from categories ranging from Pop, Rock, Country, R&B, Dance, Jazz, Classical and many more plus coverage of all the top professional and college sports including play by play games from select leagues and teams. Additional programming includes expert sports talk, uncensored entertainment, comedy, family programming, local traffic and weather and news from your most trusted sources.

Whether you purchase a SIRIUS or XM tuner, you'll need to activate and subscribe to begin enjoying the service. Easy to follow installation and setup instructions are provided with the satellite tuners. Whichever service you choose, there are a variety of programming packages available, including the option of adding "The Best of SIRIUS" programming to your XM tuner or "The Best of XM" programming to your SIRIUS tuner, enabling you to enjoy the most popular programming among both services. The "Best of" packages are not available to SIRIUS or XM Canada subscribers at this time.

Family friendly packages are also available to restrict channels featuring content that may be inappropriate for children.

To subscribe to XM, U.S. customers should visit xmradio.com or call 1-800-XMRADIO (1-800-967-2346); Canadian customers should visit xmradio.ca or call XM Listener Care at 1-877-GETXMSR (1-877-438-9677).

To subscribe to SIRIUS, U.S. and Canadian customers can call 1-888-539-SIRI (1-888-539-7474) or visit sirius.com (US) or siriuscanada.ca (Canada).

SIRIUS, XM and all related marks and logos are trademarks of Sirius XM Radio Inc. and its subsidiaries. All other marks and logos are the property of their respective owners. All rights reserved. SIRIUS and XM subscriptions sold separately. Taxes and a one-time activation fee may apply. XM tuners and home docks or SIRIUS tuners (each sold separately) are required to receive the SIRIUS or XM satellite radio service. All programming and fees subject to change. It is prohibited to copy, decompile, disassemble, reverse engineer, hack, manipulate or otherwise make available any technology or software incorporated in receivers compatible with the SIRIUS or XM Satellite Radio Systems.

Service not available in Alaska or Hawaii.

Connecting a satellite radio tuner

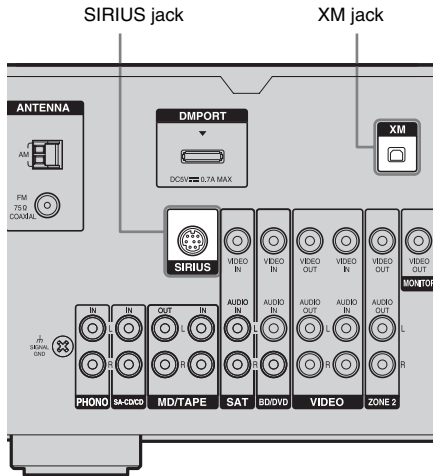

To connect to the XM jack

Before operating the system, connect the XM Mini-Tuner and Home Dock to the XM jack.

Note

To ensure optimal reception of XM's satellite signal, move your antenna to various window locations around your home to see where the best reception will be received. Most XM customers place the antenna in a south-facing window with a clear view to the sky.

To connect to the SIRIUS jack

Connect the SiriusConnect Home tuner. When you use the SiriusConnect Home tuner with this receiver, be sure to connect the AC power adaptor supplied with the tuner to a wall outlet. Keep the SiriusConnect Home tuner, antenna, and AC power adaptor away from the speaker cords and the power cord to avoid picking up noise.

Preparing to listen to a satellite radio

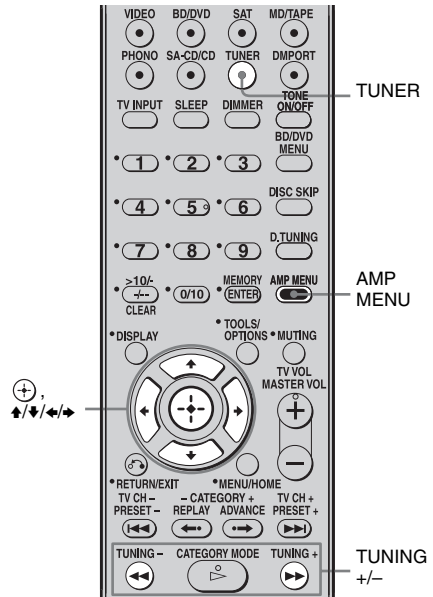

Checking the ID number

- 1** Press **TUNER** repeatedly to select “XM RADIO” or “SIRIUS”.
- 2** Press **AMP MENU**.
“1-LEVEL” appears on the display.
- 3** Press **↑/↓** repeatedly to select “3-TUNER”.
- 4** Press **⊕** or **→** to enter the menu.
- 5** Press **↑/↓** repeatedly to select “XM ID” or “SR ID”.
- 6** Press **⊕** or **→**.
The first 6 digits appear on the display.

7 Press →.

The last 6 digits appear on the display.

8 Check the XM Radio ID or Sirius Radio ID on the display and write it in the space provided here.

XM ID: _____

SR ID: _____

Using the controls on the receiver

- 1 Turn INPUT SELECTOR to select “XM RADIO” or “SIRIUS”.
- 2 Press TUNING MODE repeatedly to select “AUTO”, and then turn TUNING + or TUNING – to select channel 0.
- 3 Check the XM Radio ID or Sirius Radio ID on the display and write it in the space provided here.
XM ID: _____
SR ID: _____

If you cannot read the characters or numbers on the display, refer to the following table.

Display	Description
2	2 (two)
5	5 (five)
6	6 (six)
8	8 (eight)
0	0 (zero)
A	A
B	B
D	D
G	G
H	H
K	K
M	M
Q	Q
Z	Z

Checking receiving conditions (Antenna Aiming)

- 1 Press TUNER repeatedly to select “XM RADIO” or “SIRIUS”.
You can also use INPUT SELECTOR on the receiver.
- 2 Press AMP MENU.
“1-LEVEL” appears on the display.
- 3 Press ↑/↓ repeatedly to select “3-TUNER”.
- 4 Press ⊕ or → to enter the menu.
- 5 Press ↑/↓ repeatedly to select “XM ANT” or “SR ANT”.

continued

6 Press \oplus or \rightarrow to enter the parameter.

7 While checking the parameter, aim your antenna to where the best reception will be received.

For details on the parameter, see “XM Signal Strength” or “SIRIUS Signal Strength” below.

XM Signal Strength

Signal strength	Signal type	
	Satellite	Terrestrial
GOOD	S-3	T-3
MARG (marginal)	S-2	T-2
WEAK	S-1	T-1
NONE	S-0	T-0

SIRIUS Signal Strength

Signal Strength	Signal type	
	Satellite	Terrestrial
EXC (excellent)	S-3	T-3
GOOD	S-2	T-2
WEAK	S-1	T-1
NONE	S-0	T-0

When you have finished

Press AMP MENU.

Receiving satellite radio broadcasts

1 Press TUNER repeatedly to select “XM RADIO” or “SIRIUS”.

You can also use INPUT SELECTOR on the receiver.

2 Press TUNING + or TUNING – to select a channel.

You can also press TUNING MODE on the receiver to select “AUTO”, and then turn TUNING + or TUNING – to select a channel.

Selecting a channel of the satellite radio

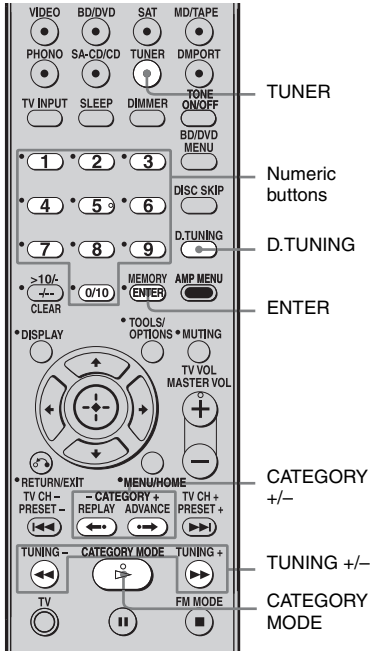

Selecting channels from a category (CATEGORY TUNING)

You can select a channel from one category or all the categories by changing the category mode.

1 Press TUNER repeatedly to select “XM RADIO” or “SIRIUS”.

You can also use INPUT SELECTOR on the receiver.

2 Press CATEGORY MODE repeatedly to select the “ONE CAT”.

- ALL CAT: You can select a channel from all the categories. The initial setting is “ALL CAT”.
- ONE CAT: You can select a channel from one category. “CAT” is displayed on the display when you set to “ONE CAT” mode.

3 Press CATEGORY + or CATEGORY – to select the category you want.

The category is selected and the channel with the lowest number in the specified category is selected.

4 Press TUNING + or TUNING – to select the channel.

You can also press TUNING MODE on the receiver to select “AUTO”, and then turn TUNING + or TUNING – to select a channel.

Notes

- When you select a channel in the “ONE CAT” mode, the channel you selected may not be the one in the category you want. This is because one channel may belong to more than one category.
- If you press CATEGORY + or CATEGORY – in the “ALL CAT” mode, the first channel of the next or previous category is selected (CATEGORY SKIP).

Selecting channels by inputting the channel number directly (DIRECT TUNING)

- 1 Press **TUNER** repeatedly to select “XM RADIO” or “SIRIUS”.

You can also use **INPUT SELECTOR** on the receiver.

- 2 Press **D.TUNING**.
- 3 Press the numeric buttons to enter the channel number.
- 4 Press **ENTER**.

You can also use **MEMORY/ENTER** on the receiver.

The selected channel is tune in.

Displaying the satellite tuner information on the front panel display

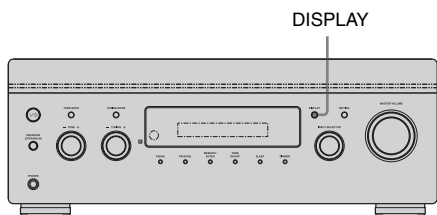

- 1 Press **DISPLAY** on the receiver repeatedly.

Each time you press **DISPLAY** while tuning in the channel, the display changes cyclically as follows:

Channel name → Channel number →
 Category name → Artist name/Feature →
 Song/Program title → Composer name
 (SIRIUS only) → Signal strength → Volume level

Presetting satellite radio channels

You can select the channels you want directly by presetting them using the preset numbers. You can preset up to 30 XM Radio channels and 30 SIRIUS Satellite Radio channels.

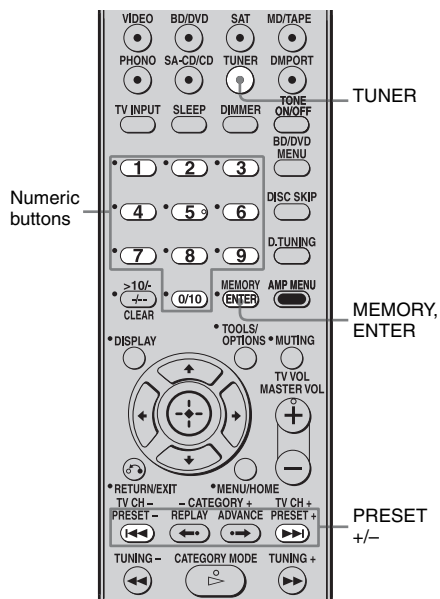

Presetting channels using the preset numbers

- 1 Press **TUNER** repeatedly to select “XM RADIO” or “SIRIUS”.
- You can also use **INPUT SELECTOR** on the receiver.
- 2 Select a channel you want to preset using **Category Tuning** (page 37) or **Direct Tuning** (page 38).

Selecting the channel by using the preset numbers**3 Press MEMORY.**

You can also use MEMORY/ENTER on the receiver.

4 Press the numeric buttons to select a preset number.

You can also select the number by pressing PRESET + or PRESET –.

You can also turn TUNING + or TUNING – on the receiver.

Preset channels from 1 to 30 are available, and channel 1 is preset for all the preset channels when you purchase the receiver.

5 Press ENTER.

You can also use MEMORY/ENTER on the receiver.

The selected channel is registered as the preset channel you selected in step 2.

6 Repeat steps 2 to 5 to preset another channel.

You can store channels from 1 to 30.

1 Press TUNER repeatedly to select “XM RADIO” or “SIRIUS”.

You can also use INPUT SELECTOR on the receiver.

2 Press PRESET + or PRESET – repeatedly to select the preset channel you want.

You can also press the numeric buttons to select the preset channel you want. Then press ENTER to enter the selection.

You can also press TUNING MODE on the receiver to select “PRESET”, and then turn TUNING + or TUNING –.

You can select preset channels from 1 to 30.

Note

The channel information you have preset may be changed if Sirius XM Radio Inc. change their channel programming.

Restricting access to specific channels

(Parental Lock) (SIRIUS only)

You can restrict access to certain channels using your own lock code. The lock code is set to “0000” as the default.

Change the lock code before you use this function for the first time. See “To change the lock code” (page 40).

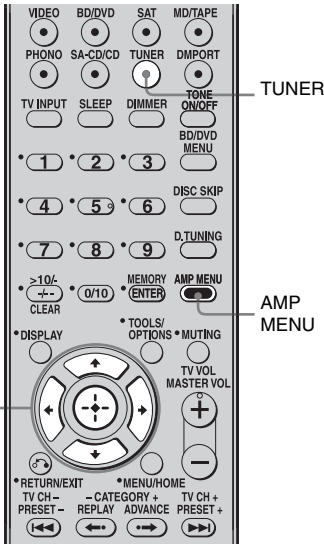

1 Press TUNER repeatedly to select “SIRIUS”.

You can also use INPUT SELECTOR on the receiver.

2 Select a channel you want to lock using Category Tuning (page 37) or Direct Tuning (page 38).

3 Press AMP MENU.

“1-LEVEL” appears on the display.

4 Press \uparrow/\downarrow repeatedly to select “3-TUNER”.

5 Press \oplus or \rightarrow to enter the menu.

6 Press \uparrow/\downarrow repeatedly to select “PARENTAL”.

7 Press \oplus or \rightarrow to enter the parameter.

8 Press \uparrow/\downarrow repeatedly to select “ON” then press \oplus .

“LOCK” appears on the display.

9 Enter your 4-digit lock code using the numeric buttons.

“LOCKED” appears on the display and the Parental Lock is set.

To delete the numbers you have entered, repeat the procedure above from step 3. Select “OFF” in step 8.

To change the lock code

1 Press TUNER repeatedly to select “SIRIUS”.

You can also use INPUT SELECTOR on the receiver.

2 Press AMP MENU.

“1-LEVEL” appears on the display.

3 Press \uparrow/\downarrow repeatedly to select “3-TUNER”.

4 Press \oplus or \rightarrow to enter the menu.

5 Press \uparrow/\downarrow repeatedly to select “CODE EDT”.

6 Press \oplus or \rightarrow to enter the parameter. “CODE” appears on the display.

7 Enter your 4-digit lock code using the numeric buttons. “NEW” appears on the display.

8 Enter a new 4-digit lock code using the numeric buttons. “CONF.” appears on the display.

- 9 Reenter the new lock code with the numeric buttons.
“CHANGED” appears on the display.

To listen to the locked channels

- 1 Press TUNER repeatedly to select “SIRIUS”.
You can also use INPUT SELECTOR on the receiver.
- 2 Select a locked channel you want to listen using Direct Tuning (page 38).
“LOCKED” appears on the display.
- 3 Enter your 4-digit lock code using the numeric buttons.
The channel is tuned in.

To cancel the Parental Lock

- 1 Press TUNER repeatedly to select “SIRIUS”.
You can also use INPUT SELECTOR on the receiver.
- 2 Select a channel you want to unlock using Direct Tuning (page 38).
“LOCKED” appears on the display.
- 3 Enter your 4-digit lock code using the numeric buttons.
The channel is tuned in.
- 4 Press AMP MENU.
“1-LEVEL” appears on the display.
- 5 Press ▲/▼ repeatedly to select “3-TUNER”.
- 6 Press ⊕ or ➔ to enter the menu.
- 7 Press ▲/▼ repeatedly to select “PARENTAL”.
- 8 Press ⊕ or ➔ to enter the parameter.
- 9 Press ▲/▼ repeatedly to select “OFF”, then press ⊕.
“LOCK” appears on the display.

- 10 Enter your 4-digit lock code using the numeric buttons.
“UNLOCKED” appears on the display.

Notes

- When you select a channel using Category Tuning, locked channels are skipped.
- When the receiver is reset to the factory settings, the lock code returns to the default (0000), but the Parental Lock settings are not removed.
- You cannot preset locked channels. If you set the Parental Lock for a preset channel, the preset information for that channel returns to the default.
- You cannot set the Parental Lock for channel 0 and channel 184.

XM Radio messages list

Message appears	Explanation	Remedies
ANTENNA	The XM antenna is not connected to the XM Mini-Tuner Dock or the XM antenna cable is damaged.	Check that the XM antenna is connected to the XM Mini-Tuner Dock securely and check the antenna cable for damage. Replace the XM antenna if the cable is damaged.
UNAUTH	You selected an XM channel that is blocked or cannot be received with your XM subscription package.	Consult the latest channel guide at www.xmradio.com (US residents) or www.xmradio.ca (Canadian residents) for the current list of channels. For information on receiving this channel, visit www.xmradio.com (US residents) or www.xmradio.ca (Canadian residents). You can also contact XM Satellite Radio at 1-800-967-2346 (US residents) or 1-877-438-9677 (Canadian residents).
NO SIGNL	The XM Mini-Tuner is not receiving the XM satellite signal. The XM antenna's view of the satellites may be blocked or the antenna is not properly aimed.	Check the antenna for obstructions and reposition the XM antenna to get a better signal reception. To optimize the antenna position, see "Checking receiving conditions (Antenna Aiming)" (page 35). Refer to the instructions supplied with the XM Mini-Tuner and Home Dock for antenna installation information.
LOADING	The XM Mini-Tuner is acquiring audio or program information from the XM satellite signal. This message can also appear if the signal is too weak.	This message should disappear when the signal is strong. If you often see this message, reposition the XM antenna for better signal reception. To optimize the antenna position, see "Checking receiving conditions (Antenna Aiming)" (page 35).
OFF AIR	You selected an XM channel that is not currently broadcasting.	Check this XM channel later. In the meantime, select another channel.
----	No artist name or song title is available for this selection.	—
CH UNAVL	The selected channel is not available. The channel may have been reassigned to a different channel number. This message may occur initially with a new radio or a radio that has not received XM's signal for an extended period.	Consult the latest channel guide at www.xmradio.com (US residents) or www.xmradio.ca (Canadian residents) for the current list of channels. For a new radio or a radio that has not received XM's signal for an extended period, allow the radio to receive the XM satellite signal for at least 5 minutes and then select the channel again.
XM TUNER	The XM Mini-Tuner is not installed or not fully seated in the XM Mini-Tuner Dock or the XM Mini-Tuner Dock is not connected to the receiver.	Confirm the XM Mini-Tuner is fully seated in the dock and check the XM Mini-Tuner dock cable is connected to the receiver.

SIRIUS Satellite Radio message list

Message appears	Explanation	Remedies
ANTENNA ERROR*	The antenna is not connected properly.	Check the connection between the SiriusConnect Home tuner and the antenna.
LINKING	The receiving condition is not good.	Try moving the antenna to another location. For details about the antenna location, refer to the instructions supplied with the SiriusConnect Home tuner.
CALL 888 539-SIRI**	You have not subscribed for the selected channel.	—
SR TUNER	The SiriusConnect Home tuner is not connected properly.	Check all the connections, and then turn the system on again. Also make sure if the AC adaptor supplied with the SiriusConnect Home tuner is connected to a wall socket.
INVALID	You have entered an invalid channel number.	The channel to be tuned-in is void due to the change by the broadcast service, or the receiving condition is not good.
LOCKED	The selected channel is locked.	—
SUB UPDT	The subscription information has been updated.	—
UPDATING	Channel information is being updated.	—
FW UPDT	The SiriusConnect Home tuner firmware is being updated.	—
----	There is no text information in the channel.	This is not an error. The text information may not be displayed depending on the system condition, for example, right after the system has received a channel.

* “ANTENNA” and “ERROR” appears on the display alternately.

**“CALL 888” and “539-SIRI” appears on the display alternately.

Enjoying the DIGITAL MEDIA PORT (DMPORT)

The DIGITAL MEDIA PORT (DMPORT) allows you to enjoy sound and image from a network system such as a portable audio/video source or computer.

By connecting a DIGITAL MEDIA PORT adapter (not supplied), you can enjoy sound and image from the connected component on the receiver.

For details, refer to the operating instructions supplied with the DIGITAL MEDIA PORT adapter.

Notes

- Do not connect an adapter other than the DIGITAL MEDIA PORT adapter.
- Before connecting the cords, be sure to disconnect the AC power cord (mains lead).
- Do not connect or disconnect the DIGITAL MEDIA PORT adapter while the receiver is turned on.
- Depending on the DIGITAL MEDIA PORT adapter, video output may not be possible.
- The DIGITAL MEDIA PORT adapters are available for purchase depending on the area.

Connecting the DIGITAL MEDIA PORT adapter

You can listen to the sound and view the images from the component connected through the DIGITAL MEDIA PORT adapter to the DMPORT jack on the receiver.

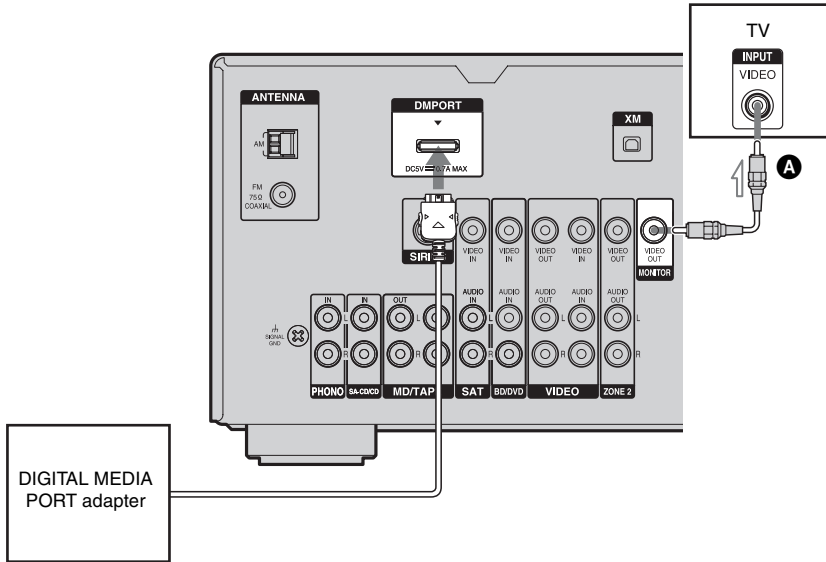

A Video cord (not supplied)

To detach the DIGITAL MEDIA PORT adapter from DMPORT jack

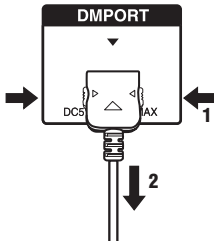

Press and hold both sides of the connector and then pull out the connector.

Notes

- When connecting the DIGITAL MEDIA PORT adapter, be sure the connector is inserted with the arrow mark facing towards the arrow mark on the DMPORT jack.
- Be sure to make DMPORT connections firmly, insert the connector straight in.
- As the connector of the DIGITAL MEDIA PORT adapter is fragile, be sure to handle with care when placing or moving the receiver.

Listening/watching a connected component through DMPORT connection

1 Press DMPORT.

You can also use the INPUT SELECTOR on the receiver to select “DMPORT”.

2 Start playback of the connected component.

The sound is played back on the receiver and the image appears on the TV.

For details, refer to the operating instructions supplied with the DIGITAL MEDIA PORT adapter.

Notes

- Depending on the type of DIGITAL MEDIA PORT adapter, you can operate the connected component by using the remote. For details on the remote button operation, see page 9.
- Be sure you have connected the MONITOR OUT of the receiver to the TV (page 45).

Changing the display

You can check the volume level, etc., by changing the information on the display. Be sure to use the buttons on the receiver for this operation.

Press DISPLAY repeatedly.

Each time you press the button, the display changes cyclically as follows.

All inputs except the FM and AM band, XM Radio and SIRIUS Satellite Radio

Index name of the input* → Selected input → Volume level

FM and AM band

Preset station name* → Frequency → Volume level

XM Radio and SIRIUS Satellite Radio

Channel name → Channel number → Category name → Artist name/Feature → Song/program title → Composer name (SIRIUS only) → Signal strength → Volume level

* Index name appears only when you have assigned one to the input or preset station (page 23, 32). Index name does not appear when only blank spaces have been entered, or it is the same as the input name.

Note

Character or marks may not be displayed for some languages.

Using the Sleep Timer

You can set the receiver to turn off automatically at a specified time.

Press SLEEP repeatedly while the power is on.

Each time you press the button, the display changes cyclically as follows:

0-30-00 → 1-00-00 → 1-30-00 → 2-00-00
→ OFF

When sleep timer is being used, "SLEEP" lights up in the display.

Tip

To check the remaining time before the receiver turns off, press SLEEP. The remaining time appears on the display. If you press SLEEP again, the sleep timer will be canceled.

Recording using the receiver

You can record from an audio/video component using the receiver. Refer to the operating instructions supplied with your recording component.

Recording onto a MiniDisc or audio tape

You can record onto a MiniDisc or audio tape using the receiver. Refer to the operating instructions supplied with your MD deck or tape deck.

- 1 Press one of the input buttons to select the playback component.**

You can also use INPUT SELECTOR on the receiver.
- 2 Prepare the playback component for playing.**

For example, insert a CD into the CD player.
- 3 Prepare the recording component.**

Insert a blank MD or tape into the recording deck and adjust the recording level.
- 4 Start recording on the recording component, then start playback on the playback component.**

Note

Sound adjustments do not affect the signal output from the MD/TAPE OUT jacks.

Recording onto a recording media

1 Press one of the input buttons to select the playback component.

You can also use INPUT SELECTOR on the receiver.

2 Prepare the playback component for playing.

For example, insert the video tape you want to copy into the VCR.

3 Prepare the recording component.

Insert a blank video tape, etc. into the recording component (VIDEO) for recording.

4 Start recording on the recording component, then start playback on the playback component.

Note

Some sources contain copy guards to prevent recording. In this case, you may not be able to record from the source.

Using multi-zone features

You can enjoy images and sounds from a component connected to the receiver in a zone (zone 2) other than the main zone. For example, you can watch the DVD in the main zone and listen to the CD in zone 2.

When using an IR repeater (not supplied), you can operate both components in the main zone and Sony receiver in zone 2 from zone 2.

- Switching the output source for the ZONE 2 OUT jacks.
- Switching the Sony receiver's power on or off in zone 2.

The following operations are described for connecting an IR repeater and operating the receiver in zone 2. When an IR repeater is not connected, use this receiver in the main zone.

About the IR REMOTE jack

You can operate the receiver without pointing the remote towards the IR repeater of the receiver if you connect an IR repeater (not supplied) to the IR REMOTE jack.

Use an IR repeater when you install the receiver in a place where signals from the remote cannot reach.

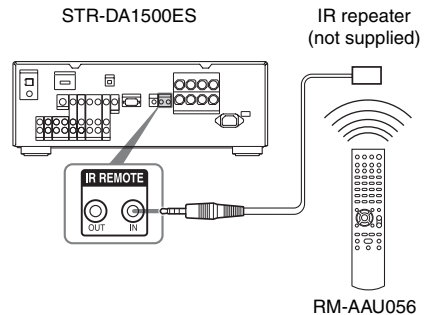

Making a multi-zone operation

Zone 2 connections

Outputs sound from speakers in zone 2 using the receiver and another amplifier.

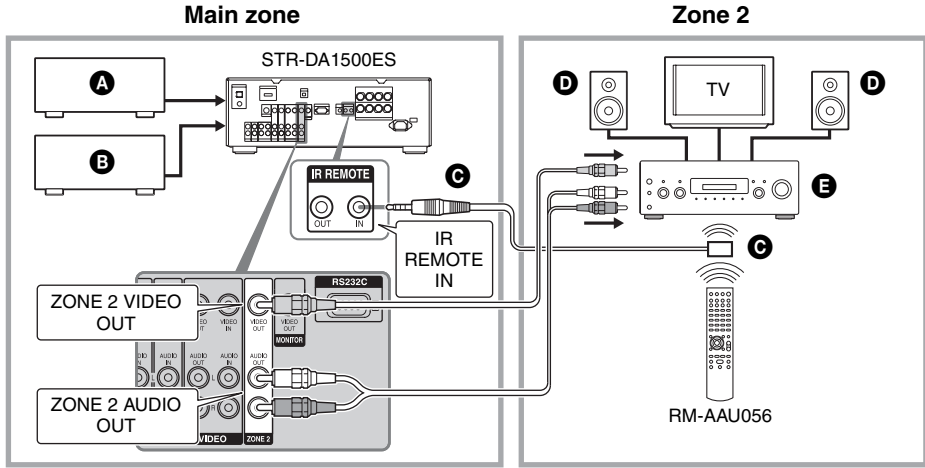

- A** Audio component
- B** Video component
- C** IR repeater (not supplied)
- D** Speakers
- E** Sony Amplifier/Receiver

Operating the receiver from zone 2

The following operations are described for connecting an IR repeater and operating the receiver in zone 2. When an IR repeater is not connected, use this receiver in the main zone.

Tip

Even when this receiver is in standby mode (press I/⏻ on the remote to turned off this receiver), the receiver in zone 2 remains turned on. To turn off all receivers, press I/⏻ and AV I/⏻ on the RM-AAU056 remote at the same time (SYSTEM STANDBY).

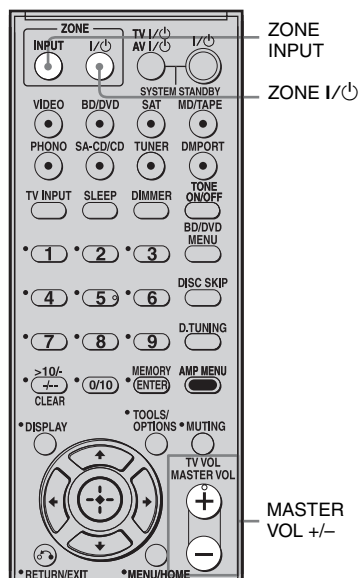

1 Turn on the main receiver (this receiver).

2 Turn on the receiver in zone 2.

3 Press ZONE I/⏻.

The zone function is activated.

4 Press ZONE INPUT repeatedly to select the source you want.

5 Adjust to a suitable volume.

Adjust the volume using the receiver in zone 2.

To finish the zone 2 operation

Press ZONE I/⏻.

Changing button assignments

You can change the factory settings of the input buttons to suit the components in your system. For example, if you connect a DVD recorder to the VIDEO jacks on the receiver, you can set the VIDEO button on this remote to control the DVD recorder.

Note

You cannot change the settings of PHONO, TUNER and DMPORT buttons.

1 Hold down the input button of which you want to change the assignment.

Example: Hold down VIDEO.

2 Referring to the table below, press the corresponding button for the category you want.

Example: Press 3.

Now you can use the VIDEO button to control the DVD recorder.

Categories and the corresponding buttons

Categories	Press
VCR (command mode VTR 3)	1
DVD player/DVD recorder (command mode DVD1) ^{a)}	2
DVD recorder (command mode DVD3) ^{a)}	3
CD player	4
Euro Digital Satellite Receiver	5
DVR (Digital CATV terminal)	6
DSS (Digital Satellite Receiver)	7
Blu-ray disc player (command mode BD1) ^{b)}	8
Blu-ray disc recorder (command mode BD3) ^{b)}	9
MD deck	0/10
Tape deck	-/--

^{a)} Sony DVD recorders are operated with a DVD1 or DVD3 setting. For details, refer to the operating instructions supplied with the DVD recorders.

^{b)} For details on the BD1 or BD3 setting, refer to the operating instructions supplied with the Blu-ray disc player or Blu-ray disc recorder.

To clear all remote button assignments

While holding down MASTER VOL \ominus , press I/⏻ and ZONE I/⏻.

The remote is reset to its factory settings.

Precautions

On safety

Should any solid object or liquid fall into the cabinet, unplug the receiver and have it checked by qualified personnel before operating it any further.

On power sources

- Before operating the receiver, check that the operating voltage is identical with your local power supply.

The operating voltage is indicated on the nameplate on the back of the receiver.

- The unit is not disconnected from the AC power source (mains) as long as it is connected to the wall outlet, even if the unit itself has been turned off.
- If you are not going to use the receiver for a long time, be sure to disconnect the receiver from the wall outlet. To disconnect the AC power cord (mains lead), grasp the plug itself; never pull the cord.
- One blade of the plug is wider than the other for the purpose of safety and will fit into the wall outlet only one way. If you are unable to insert the plug fully into the outlet, contact your dealer.
- The AC power cord (mains lead) must be changed only at a qualified service shop.

On heat buildup

Although the receiver heats up during operation, this is not a malfunction. If you continuously use this receiver at a large volume, the cabinet temperature of the top, side and bottom rises considerably. To avoid burning yourself, do not touch the cabinet.

On placement

- Place the receiver in a location with adequate ventilation to prevent heat buildup and prolong the life of the receiver.
- Do not place the receiver near heat sources, or in a place subject to direct sunlight, excessive dust, or mechanical shock.
- Do not place anything on top of the cabinet that might block the ventilation holes and cause malfunctions.
- Do not place the receiver near equipment such as a television, VCR, or tape deck. If the receiver is being used in combination with a television, VCR, or tape deck, and is placed too close to that equipment, noise may result, and picture quality may suffer. This is especially likely when using an indoor antenna (aerial). Therefore, we recommend using an outdoor antenna (aerial).
- Use caution when placing the receiver on surfaces that have been specially treated (with wax, oil, polish, etc.) as staining or discoloration of the surface may result.

On operation

Before connecting other components, be sure to turn off and unplug the receiver.

On cleaning

Clean the cabinet, panel, and controls with a soft cloth slightly moistened with a mild detergent solution. Do not use any type of abrasive pad, scouring powder, or solvent, such as alcohol or benzine.

If you have any questions or problems concerning your receiver, please consult your nearest Sony dealer.

Troubleshooting

If you experience any of the following difficulties while using the receiver, use this troubleshooting guide to help you remedy the problem.

Audio

There is no sound, no matter which component is selected, or only a very low-level sound is heard.

- Check that the speakers and components are connected correctly and securely.
- Check that all speaker cords are connected correctly.
- Check that both the receiver and all components are turned on.
- Check that MASTER VOLUME control is not set at VOL $-\infty$ dB. Try to set it at about VOL -40.0 dB.
- Check that the SPEAKERS (OFF/A/B/A+B) is not set to OFF.
- Check that headphones are not connected.
- Press MUTING to cancel the muting function.
- Check that you have selected the correct component with the input buttons.
- The protective device on the receiver has been activated. Turn off the receiver, eliminate the short-circuit problem, and turn on the power again.

There is no sound from a specific component.

- Check that the component is connected correctly to the audio input jacks for that component.
- Check that the cord(s) used for the connection is (are) fully inserted into the jacks on both the receiver and the component.

There is no sound from one of the front speakers.

- Connect a pair of headphones to the PHONES jack to verify that sound is output from the headphones. If only one channel is output from the headphones, the component may not be connected to the receiver correctly. Check that all the cords are fully inserted into the jacks on both the receiver and the component. If both channels are output from the headphones, the front speaker may not be connected to the receiver correctly. Check the connection of the front speaker which is not outputting any sound.
- Make sure you have connected to both the L and R jacks of an analog component, and not only to either the L or R jack. Use an audio cord (not supplied).

The left and right sounds are unbalanced or reversed.

- Check that the speakers and components are connected correctly and securely.
- Adjust the balance parameters using the LEVEL menu.

There is severe hum or noise.

- Check that the speakers and components are connected securely.
- Check that the connecting cords are away from a transformer or motor, and at least 10 feet (3 meters) away from a TV set or fluorescent light.
- Move your audio components away from the TV.
- The plugs and jacks are dirty. Wipe them with a cloth slightly moistened with alcohol.

Recording cannot be carried out.

- Check that the components are connected correctly (page 14).
- Select the source component using the input buttons (page 22).

There is no sound from the component connected to the DIGITAL MEDIA PORT adapter.

- Adjust the volume of this receiver.
 - The DIGITAL MEDIA PORT adapter and/or component is not connected correctly. Turn off the receiver, then reconnect the DIGITAL MEDIA PORT adapter and/or component.
 - Check the DIGITAL MEDIA PORT adapter and/or component device to make sure it supports this receiver.
-

Video

There is no picture or an unclear picture appears on the TV screen.

- Select the appropriate input using the input buttons.
 - Set your TV to the appropriate input mode.
 - Move your audio components away from the TV.
 - Depending on the DIGITAL MEDIA PORT adapter, video output may not be possible.
-

Recording cannot be carried out.

- Check that the components are connected correctly (page 15).
 - Select the source component using the input buttons (page 22).
-

Tuner

The FM reception is poor.

- Use a 75-ohm coaxial cable (not supplied) to connect the receiver to an outdoor FM antenna (aerial) as shown below. If you connect the receiver to an outdoor antenna (aerial), ground it against lightning. To prevent a gas explosion, do not connect the ground (earth) wire to a gas pipe.

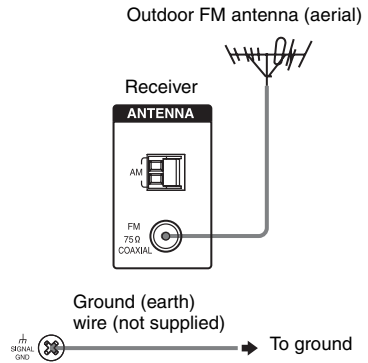

Radio stations cannot be tuned in.

- Check that the antennas (aerials) are connected securely. Adjust the antennas (aerials) and connect an external antenna (aerial), if necessary.
- Keep the satellite radio antenna away from the speaker cords and the power cord (mains lead) to avoid picking up noise.
- The signal strength of the stations is too weak (when tuning in with automatic tuning). Use direct tuning.
- Make sure you set the tuning interval correctly (when tuning in AM stations with direct tuning).
- No stations have been preset or the preset stations have been cleared (when tuning by scanning preset stations). Preset the stations (page 31).
- Press DISPLAY repeatedly on the receiver so that the frequency appears on the display.

The system cannot receive satellite channels at all.

- The receiving condition is not good. Move the antenna to the place where the condition is good.
 - Check that you subscribed to the desired satellite radio service (page 33).
-

Remote commander

The remote does not function.

- Point the remote at the remote sensor on the receiver.
 - Remove any obstacles in the path between the remote and the receiver.
 - Replace all the batteries in the remote with new ones, if they are weak.
 - Make sure you select the correct input on the remote.
-

Error messages

If there is a malfunction, the display shows a message. You can check the condition of the system by the message. Refer to the following table to solve the problem. If any problem persists, consult your nearest Sony dealer.

PROTECT

Irregular current is output to the speakers. The receiver will automatically turn off after a few seconds. Check the speaker connection and turn on the power again.

For other messages, see “XM Radio messages list” (page 42) and “SIRIUS Satellite Radio message list” (page 43).

If the problem persist

Consult your nearest Sony dealer. Note that if service personnel changes some parts during repair, these parts may be retained.

Reference sections for clearing the receiver's memory

To clear	See
All memorized settings	page 20

Specifications

AUDIO POWER SPECIFICATIONS

POWER OUTPUT AND TOTAL HARMONIC DISTORTION: (Models of area code UC only)

With 8 ohms loads, both channels driven, from 20 – 20,000 Hz; rated 95 watts per channel minimum RMS power, with no more than 0.09% total harmonic distortion from 250 milliwatts to rated output.

Amplifier section

Models of area code UC¹⁾

Minimum RMS Output Power (8 ohms, 20 Hz – 20 kHz, THD 0.09%)

95 W + 95 W

Stereo Mode Output Power (8 ohms, 1 kHz, THD 0.7%)

105 W + 105 W

¹⁾Measured under the following conditions:

Area code	Power requirements
UC	120 V AC, 60 Hz

Frequency response

PHONO RIAA equalization curve
±0.5 dB

Analog 10 Hz – 70 kHz
+0.5/-2 dB (Bass: 0 dB,
Treble: 0 dB)

Inputs

PHONO Sensitivity: 2.5 mV
Impedance: 50 kohms
S/N²⁾: 90 dB
(A, 20 kHz LPF)³⁾

Analog Sensitivity: 150 mV/
50 kohms
S/N²⁾: 96 dB
(A, 150 mV³⁾)

Outputs (Analog)

AUDIO OUT Voltage: 150 mV/10
kohms

Equalizer

Gain levels ±10 dB, 1 dB step

²⁾INPUT SHORT (Bass: 0 dB, Treble: 0 dB).

³⁾Weighted network.

FM tuner section

Tuning range 87.5 - 108.0 MHz

Antenna (aerial) FM wire antenna (aerial)

Antenna (aerial) terminals

75 ohms, unbalanced

Intermediate frequency

10.7 MHz

AM tuner section

Tuning range

Area code	Tuning scale	
	10 kHz step	9 kHz step
UC	530 – 1,710 kHz	531 – 1,710 kHz

Antenna (aerial) Loop antenna (aerial)

Intermediate frequency

450 kHz

Video section

Inputs/Outputs

Video: 1 Vp-p/75 ohms

General

Power requirements

Area code	Power requirements
UC	120 V AC, 60 Hz

Power output (DIGITAL MEDIA PORT)

DC OUT: 5 V, 0.7 A MAX

Power consumption

Area code	Power consumption
UC	210 W

Power consumption (during standby mode)

0.3 W (when “RS232C” is
set to “OFF”)

Dimensions (w/h/d) (Approx.)

17 × 6 1/4 × 15 3/8 inches
(430 × 157.5 × 388 mm)
including projecting parts
and controls

Mass (Approx.) 19 lb 14 oz (9.0 kg)

Supplied accessories

Operating Instructions (this manual)

Quick Setup Guide (1)

FM wire antenna (aerial) (1)

AM loop antenna (aerial) (1)

RM-AAU056 Remote Commander (1)

R6 (size-AA) batteries (2)

AC power cord (mains lead) (1)

For details on the area code of the component you are using, see page 4.

Design and specifications are subject to change without notice.

Halogenated flame retardants are not used in the certain printed wiring boards.

Index

Symbols

⏏ SIGNAL GND terminal
14

Numerics

12V Trigger 25, 28

B

Blu-ray disc player
connecting 16

C

CD player
connecting 14

D

DIGITAL MEDIA PORT
connecting 45
DVD player
connecting 16
DVD recorder
connecting 18

E

Error messages 55

I

Initial setup 20

L

Lock Code 40

M

Menu
EQ 26
LEVEL 26
SYSTEM 28
TUNER 27
Muting 23

N

Naming 23, 32

P

Parental Lock 40

R

Recording
onto a MiniDisc or audio
tape 47
onto a recording media
48
Remote commander 9
RS232C Control 28

S

Satellite tuner
connecting 17
Selecting
component 22
speaker system 21
Set-top box
connecting 17
SIRIUS Satellite Radio 33
Sleep Timer 47
Speakers
connecting 13
Super Audio CD player
connecting 14

T

Tuner
connecting 19
Tuning
automatically 29
directly 30
to preset stations 31

V

VCR
connecting 18

X

XM Radio 33



* 4 1 2 9 7 4 3 1 1 * (1)